



AI TONG SCHOOL

2008

SEMESTRAL ASSESSMENT 2

PRIMARY 5

MATHEMATICS
Paper 1
(Booklet A and B)

DURATION : 50 min

DATE : 23 October 2008

INSTRUCTIONS

Do not open the booklet until you are told to do so.

Follow all instructions.

Answer all questions.

You are not allowed to use a calculator.

Name : _____ ()

Class : Primary 5 (_____)

Parent's Signature: _____
Date : _____

Paper 1	40
Paper 2	60
Total	100

Paper 1

Booklet A

Questions 1 to 10 carry 1 mark each. Questions 11 to 15 carry 2 marks each.

For each question, four options are given. One of them is the correct answer.

Make your choice (1, 2, 3 or 4). Shade the oval (1, 2, 3 or 4) on the Optical Answer Sheet. (20 marks)

1 In 3 486 029, the digit 8 stands for $8 \times$ _____.

- (1) 100
- (2) 1000
- (3) 10 000
- (4) 100 000

2 Find the value of $7 \times (2 + 16 \div 2) - 1$.

- (1) 14
- (2) 21
- (3) 62
- (4) 69

3 Which of the following has the largest value?

- (1) $\frac{5}{7}$
- (2) $\frac{5}{8}$
- (3) $\frac{5}{9}$
- (4) $\frac{5}{10}$

4 A dictionary is six times as heavy as an exercise book. What is the ratio of the mass of the dictionary to the total mass of the exercise book and the dictionary?

- (1) 1 : 6
- (2) 6 : 1
- (3) 6 : 7
- (4) 7 : 6

5 The mass of a metal desk is 45 kg when rounded off to the nearest kilogram. Which of the following is the actual mass of the metal desk in kg?

- (1) 44.05
- (2) 44.49
- (3) 45.45
- (4) 45.50

6 David spent \$24 and had \$56 left. What percentage of his money did he spend?

- (1) 30 %
- (2) 36 %
- (3) 42 %
- (4) 70 %

7 What fraction of the figure is shaded?

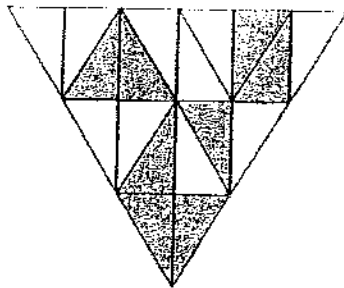

- (1) $\frac{1}{4}$
- (2) $\frac{4}{5}$
- (3) $\frac{4}{9}$
- (4) $\frac{5}{9}$

8 The figure below is not drawn to scale. FG is a straight line. Find $\angle h$.

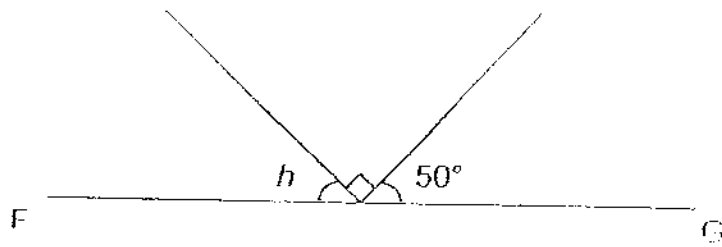

- (1) 30°
- (2) 40°
- (3) 50°
- (4) 60°

9 The figure below is not drawn to scale. ABC is a right-angled triangle and BCD is an equilateral triangle. AE is a straight line. Find $\angle ACD$.

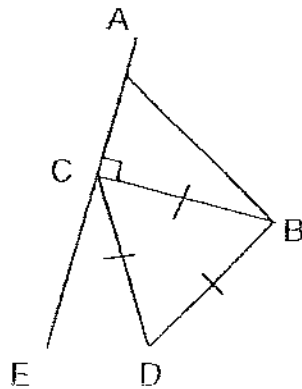

- (1) 60°
- (2) 90°
- (3) 120°
- (4) 150°

- 10 WXYZ is a trapezium. Which of the following statement is correct?

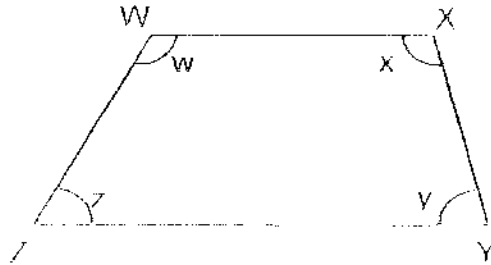

- (1) $\angle y + \angle z = 180^\circ$
(2) $\angle x + \angle z = 180^\circ$
(3) $\angle w = \angle y$
(4) $\angle w + \angle z = \angle x + \angle y$
- 11 What is the value of the digit 5 in the sum of 569 276 and 56 000?
- (1) 500
(2) 5000
(3) 50 000
(4) 500 000
- 12 The average mass of Caili and her three sisters is 42 kg. If Caili is 48 kg, what is the average mass of her three sisters in kg?
- (1) 18
(2) 24
(3) 30
(4) 40

13 Yin Lin bought a certain length of ribbon. She used $\frac{3}{10}$ of it to wrap a present.

Then she gave $\frac{3}{7}$ of the remainder to her friend. What fraction of the ribbon she bought was left?

(1) $\frac{2}{5}$

(2) $\frac{3}{5}$

(3) $\frac{19}{70}$

(4) $\frac{51}{70}$

14 There are 54 black and white beads in a box. $\frac{1}{6}$ of the beads are black. Jia Ling uses 12 white beads to string a bracelet. What is the ratio of the number of black beads to the number of white beads left in the box?

(1) 1 : 5

(2) 3 : 11

(3) 5 : 1

(4) 11 : 3

15 Adrian had \$60. He spent 60% of it on a book and $\frac{1}{4}$ of the remainder on a pen.

How much did the pen cost?

(1) \$6

(2) \$9

(3) \$18

(4) \$24

Booklet B

Questions 16 to 25 carry 1 mark each. Write your answers in the spaces provided. For questions which require units, give your answers in the units stated. (10 marks)

16 Write *five hundred and ten thousand and eight* in numerals.

Ans: _____

17 A mini bus can carry only 15 children. How many mini buses are needed to carry 390 children?

Ans: _____

18 Express $\frac{11}{20}$ as a percentage.

Ans: _____ %

19 There are goldfish and angelfish in a fish tank. $\frac{4}{15}$ of the total number of fish are angelfish. What is the ratio of the number of goldfish to the number of angelfish?

Ans: _____

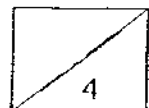

20 Ryan has ~~thrice~~ as many 10¢ coins as 20¢ coins. How much money does he have in all if he has 40 coins?

Ans: \$ _____

21 String A is $3\frac{9}{20}$ m long. String B is 230 cm longer than String A. Find the length of String B.

Ans: _____ m

22 A salesman uses an average of 7025 ml of petrol a day. How much petrol will he use in 1 week?

Ans: _____ ml

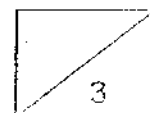

23 In the figure below, not drawn to scale, find the value of y

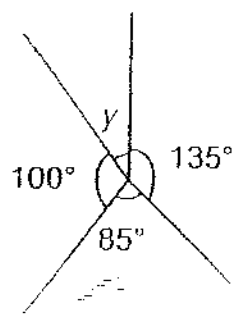

Ans: _____

24 Triangle PQR is not drawn to scale. Find $\angle QRP$

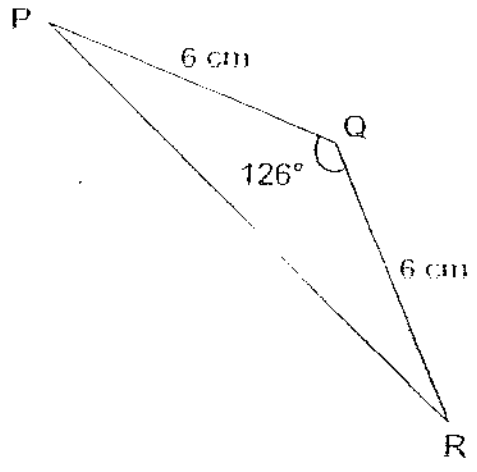

Ans: _____

25 Figure ABCD is not drawn to scale. $\angle d = 74^\circ$. Find $\angle c$.

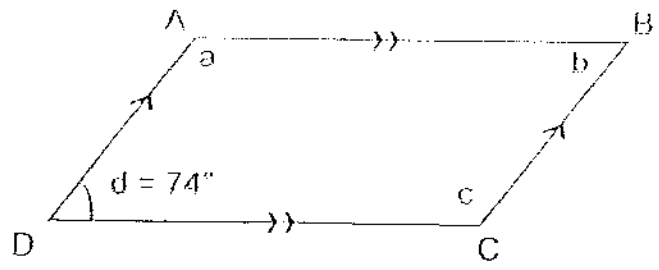

Ans: _____

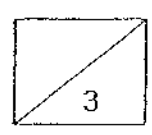

Questions 26 to 30 carry 2 marks each. Show your working clearly in the space provided for each question and write your answers in the spaces provided. For questions which require units, give your answers in the units stated. (10 marks)

26 Find the area of the shaded triangle.

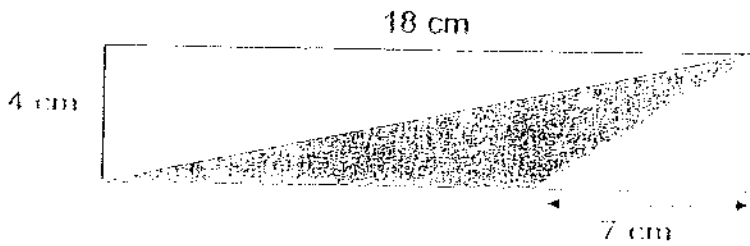

Ans: _____ cm^2

27 An equal amount of water is poured into two empty tanks, A and B. If Tank A is half-filled with water, what is the height of the water level in Tank B?

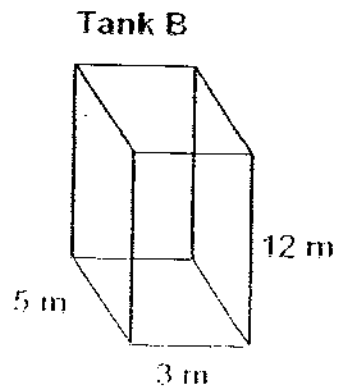
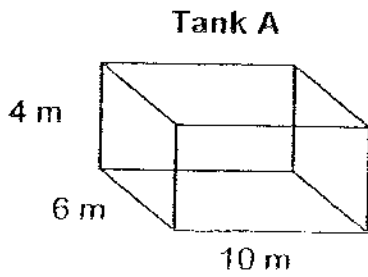

Ans: _____ m

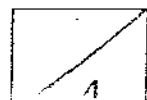

28 The usual price of a television set was \$3100. At the Great Singapore Sale, it was sold at a discount of 20%. What was the price of the television set after the discount?

Ans: \$ _____

29 The figure below is not drawn to scale. CD and EF are straight lines. Find g .

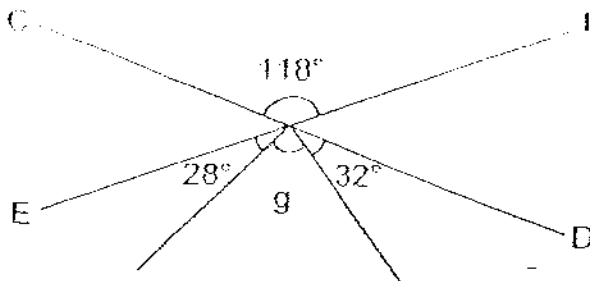

Ans: _____

30 The figure below is not drawn to scale. PQRS is a parallelogram. $\angle QRS$ is $\frac{1}{3}$ of $\angle RST$. Find $\angle RST$.

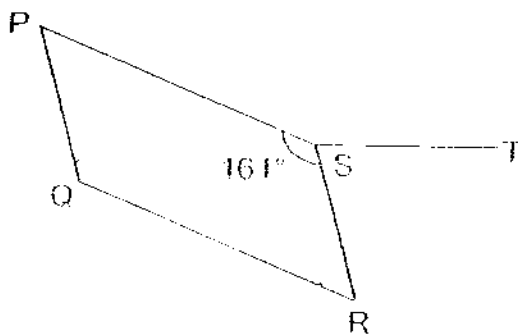

Ans: _____



AI TONG SCHOOL

2008

SEMESTRAL ASSESSMENT 2

PRIMARY 5

MATHEMATICS
Paper 2

DURATION : 1 hour 40 min

DATE : 23 October 2008

INSTRUCTIONS

Do not open the booklet until you are told to do so.

Follow all instructions.

Answer all questions.

You are allowed to use a calculator.

Name : _____ ()

Class : Primary 5 (_____)

Parent's Signature: _____
Date : _____

Total	60
-------	----

Paper 2

Questions 1 to 5 carry 2 marks each. Show your working clearly in the space provided for each question and write your answers in the spaces provided.

For questions which require units, give your answers in the units stated. (10 marks)

- 1 A group of boys share some cards among them. If each boy gets 5 cards, there will be 3 extra cards. If each boy gets 6 cards, there will be short of 3 cards. What is the least possible number of boys in the group?

Ans: _____

- 2 Find the total length of three poles, 1.07 m, $2\frac{7}{8}$ m and 920 cm long. Give your answer as a decimal correct to 2 decimal places.

Ans: _____ m

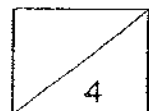

3 Bala's savings is $\frac{3}{8}$ of Josh's savings. Together, their savings is \$935. How much is Bala's savings?

Ans: \$ _____

4 The figure below is not drawn to scale. AB is a straight line. Find the difference between $\angle c$ and $\angle d$.

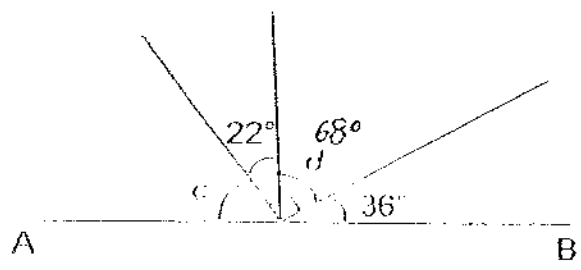

Ans: _____

5 A rectangular tank, measuring 80 cm by 50 cm by 30 cm, is half-filled with water. If the water is drained out at a rate of 12 litres per minute, how long will it take to empty the water from the tank? (1 litre = 1000 cm³)

Ans: _____ min

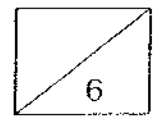

For questions 6 to 18, show your working clearly in the space provided for each question and write the answers in the spaces provided.

The number of marks available is shown in the brackets [] at the end of each question or part-question. (50 marks)

6 $\frac{5}{9}$ of a number is 105. What is $\frac{2}{7}$ of the number?

Ans: _____ [3]

7 The admission fee for an exhibition was \$5 for each adult and \$3.50 for each child. A total of \$4688 was collected. If 28 more children than adults visited the exhibition, how many adults visited the exhibition?

Ans: _____ [3]

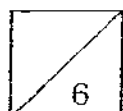

- 8 The figure below is not drawn to scale. Triangle ABC is a right-angled triangle and DEFG is a parallelogram. Find
- $\angle CDG$
 - $\angle DEF$
 - $\angle ABC$

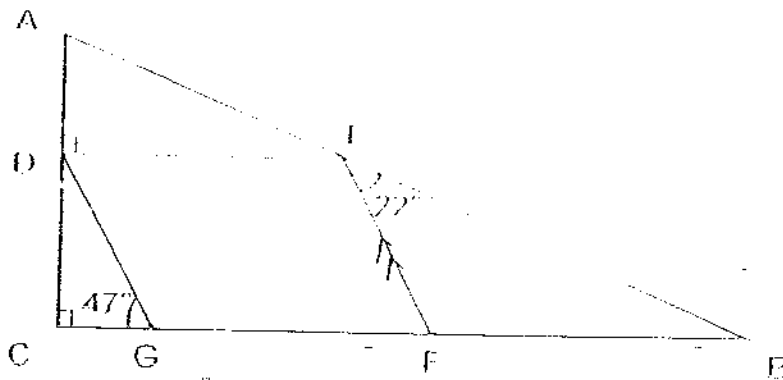

Ans: $\angle CDG =$ _____ [1]

$\angle DEF =$ _____ [1]

$\angle ABC =$ _____ [1]

- 9 The figure below is not drawn to scale. XY is a straight line. $\angle u$ is twice the size of $\angle s$. Find

a) $\angle u$

b) $\angle t$

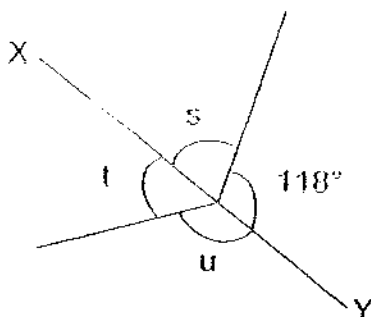

Ans: $\angle u =$ _____ [2]

$\angle t =$ _____ [1]

- 10 The average of ten numbers in a group is 604. Two of the numbers, with an average of 592, are removed from the group. What is the average of the remaining numbers in the group?

Ans: _____ [3]

- 11 Josh has \$150. Ken has $\frac{7}{10}$ of Josh's amount. Larry has $\frac{1}{4}$ of what Josh and Ken have. How much money do the three boys have in all?

Ans: _____ [3]

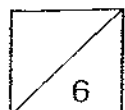

12 Study the pattern of squares and the table given below carefully.



Pattern 1 

Pattern 2 

Pattern 3 

Pattern 4 

Pattern 5 

Pattern	1	2	3	4	5	6	10	12
Number of squares	1	2	3	4	5	6	10	12
Number of lines	4	7	10		16	19	31	

- How many lines are there in pattern 4?
- How many lines are there in pattern 12?
- How many lines are there in pattern 64?

Ans: a) _____ [1]

b) _____ [1]

c) _____ [2]

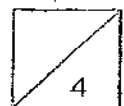

- 13 The figure below is not drawn to scale. Line PQ is 14 cm. Find the area of the shaded part

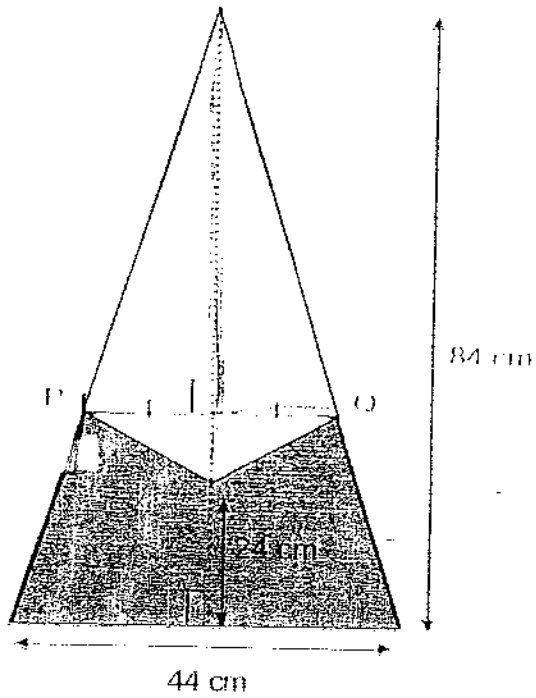

Ans. _____ [4]

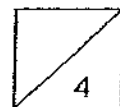

- 14 The ratio of the number of boys to the number of girls in a school was 7 : 3 in 2007. After 478 boys and 862 girls joined the school in 2008, there are now an equal number of boys and girls. What is the enrolment of the school in 2008?

Ans: _____ [4]

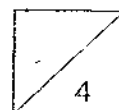

- 15 A farmer has 1200 animals on his farm. 20% of them are chicken, 65% of the remainder are ducks and the rest are cows.
- a) How many ducks are there on the farm?
 - b) What percentage of farm animal are cows?

Ans: a) _____ [3]

b) _____ [2]

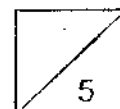

- 16 Belle, Chris and Dion sold handmade cookies to raise funds for charity. Belle sold $\frac{1}{5}$ of the cookies. Chris and Dion sold the remaining cookies in the ratio 2 : 3. Dion sold 91 more cookies than Belle. How much did the girls collect if the cookies were sold at 5 for \$2.80?

Ans: _____ [5]

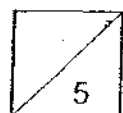

- 17 Feng Rui has 225 more Singapore stamps than Malaysia stamps. After selling $\frac{3}{5}$ of the Singapore stamps and $\frac{1}{3}$ of the Malaysia stamps, he has 858 stamps left. How many stamps does Feng Rui have at first?

Ans: _____ [5]

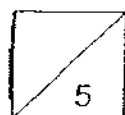

- 18 The figure below is not drawn to scale. $ABEF$ is a square, $BCEG$ is a rhombus and CDE is an isosceles triangle. BD and FD are straight lines. G is the midpoint of AF .
- Find
- $\angle DCE$
 - $\angle ABC$
 - $\angle BGF$

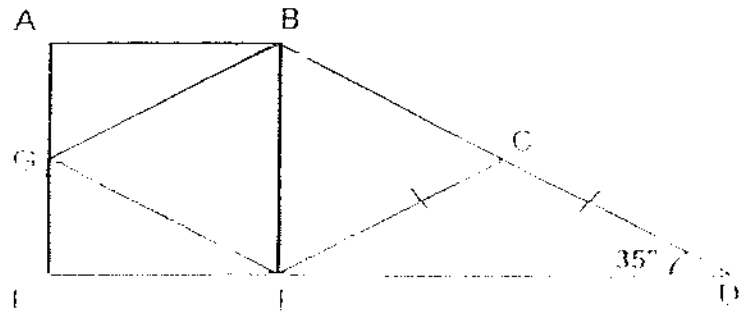

Ans: $\angle DCE =$ _____ [1]

$\angle ABC =$ _____ [2]

$\angle BGF =$ _____ [2]

End of Paper

--- CHECK YOUR WORK CAREFULLY ---

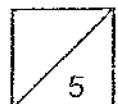

ANSWER SHEET

EXAM PAPER 2008

SCHOOL : AITONG PRIMARY SCHOOL

SUBJECT : PRIMARY 5 MATHEMATICS

TERM : SA 2

Q1	Q2	Q3	Q4	Q5	Q6	Q7	Q8	Q9	Q10	Q11	Q12	Q13	Q14	Q15
3	4	1	2	4	1	3	2	4	4	2	4	1	3	1

16) 510008

17) 26

18) 55%

19) 11:4

20) \$5.00

21) 5.75m

22) 49175ml

23) 40°

24) 27°

25) 106°

26) 22cm

27) 8m

28) $\$3100 \div 100 = \31

$\$31 \times 20 = \620

$\$3100 - \$620 = \$2480$

29) $\angle X = 180^\circ - 118^\circ = 62^\circ$

$\angle g = 180^\circ - 32^\circ - 28^\circ - 62^\circ = 58^\circ$

30) $\angle PQR = 161^\circ$

$\angle QRS = 180^\circ - 161^\circ = 19^\circ$

$\angle RST = 19^\circ \times 3 = 57^\circ$

paper 2

1) 6 boys

2) 13.15m

3) \$255

4) $90^\circ - 22^\circ - 68^\circ$

$$90^\circ + 36^\circ = 126^\circ$$

$$180^\circ - 126^\circ = 54^\circ$$

$$68^\circ - 54^\circ = 14^\circ$$

5) 5 min

6) $5/9 \times 11 = 105$

$$11 = 105 \div 5/9$$

$$\square = 105 \times 9/5$$

$$\square = 189$$

$$189 \times 2/7 = 54$$

2/7 of the number is 54

7) $28 \times \$3.50 = \98

$$\$4688 - \$98 = \$4590$$

$$\$5 + \$3.50 = \$8.50$$

$$4590 \div 8 = 540$$

There are 540 adults.

8) a) $\angle CDG = 180^\circ - 90^\circ - 47^\circ = 43^\circ$

$\angle CDG$ is 43°

b) $\angle DGF = 180^\circ - 47^\circ = 133^\circ$

$\angle DEF = 133^\circ$

c) $\angle AED = 180^\circ - 133^\circ - 22^\circ = 25^\circ$

$\angle CAB = 180^\circ - 25^\circ - 90^\circ = 65^\circ$

$\angle ABC = 180^\circ - 90^\circ - 65^\circ = 25^\circ$

$\angle ABC$ is 25°

9) $\angle S = 180^\circ - 118^\circ = 62^\circ$

$\angle U = 62^\circ \times 2 = 124^\circ$

$\angle T = 180^\circ - 124^\circ = 56^\circ$

$\angle u$ is 124°

$\angle t$ is 56°

10) $604 \times 10 = 6040$

$592 \times 2 = 1184$

$6040 - 1184 = 4856$

$4856 \div 8 = 607$

The average of the remaining number is 607.

11) $10u$ represents \$150

$1u$ represents $\$150 \div 10 = 15$

Ken and Josh = $15 \times 17 = 255$

Larry = $\frac{1}{4} \times \$255 = \63.75

$\$63.75 + \$255 = \$318.75$

The three boys have \$318.75 altogether.

12) a) $10 + 3 = 13$

There are 13 lines in Pattern 4.

b) $31 + 6 = 37$

There are 37 lines in Pattern 12

c) 193 lines

13) $\frac{1}{2} \times 60 \times 7 \times 2 = 420$

$2 \times \frac{1}{2} \times 60 \times 7 = 420$

$\frac{1}{2} \times 44 \times 84 = 1848$

$1848 - 420 = 1428$

14) $862 - 478 = 384$

4u represent 384

1u represent $384 \div 4 = 96$

$(96 \times 10) + 478 + 862 = 2300$

15)a) $20 \times 1200 = 240$ (chicken)

100

$1200 - 240 = 960$

$65 \times 960 = 624$

100

There are 624 ducks in the farm.

b) $1200 - 624 - 240 = 336$ (cows)

$336 \times 100 = 28\%$

1200

There are 28% of cows in the farm.

16) B : C : D

5 : 8 : 12

$12u - 5u = 7u$

7u represent 91 cookies

1u represent $91 \div 7 = 13$

$(5 + 8 + 12)u = 25u$

$25 \times 13 = 325$

$325 \div 5 = 65$

$65 \times \$2.80 = \182

The girls collected \$182.

17) 1665

18)a) $\angle CED = 35^\circ$

$\angle DCE = 180^\circ - 35^\circ - 35^\circ = 110^\circ$

$\angle DCE$ is 110°

b) BGE and BEC are equilateral triangle

$60^\circ + 60^\circ = 120^\circ$

CEG = 120°

$FEG = 180^\circ - 120^\circ - 35^\circ = 25^\circ$

ABG = 25°

$ABC = 25^\circ + 120^\circ = 145^\circ$

ABC is 145°

$$18)c) GFE = 180^\circ - 90^\circ - 25^\circ = 65^\circ$$

$$BGF = 60^\circ + 65^\circ = 125^\circ$$

$\angle BGF$ is 125°